

LCR1625

25A Thyristor High Voltage, Phase Control SCR

$I_{T(AV)}$	25 A
V_{DRM}/V_{RRM}	1600 V
I_{GT}	15-50 mA
T_J	-40°C to +125°C

Features

- Flexible solution for reliable AC power rectification
- Easy control peak current at charger power up to reduce passive / electromechanical components

Applications

- On-board and off-board EV / HEV battery chargers
- Renewable energy inverters

Description

The LCR1625 high voltage series of silicon controlled rectifiers are specifically designed for medium power switching and phase control applications.

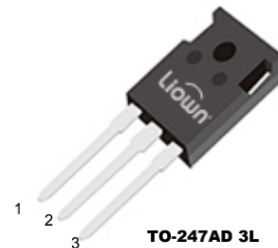
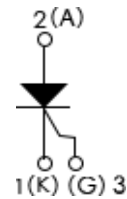

MAJOR RATINGS AND CHARACTERISTICS			
PARAMETER	TEST CONDITIONS	VALUES	UNITS
$I_{T(AV)}$	Sinusoidal waveform	25	A
I_{RMS}		40	
V_{RRM}/V_{DRM}		1600	V
I_{TSM}		400	A
V_T	20 A, $T_J = 25\text{ }^\circ\text{C}$	1.4	V
dV/dt		500	V/ μs
dI/dt		150	A/ μs
T_J		-40 to +125	$^\circ\text{C}$

ABSOLUTE MAXIMUM RATINGS					
PARAMETER	SYMBOL	TEST CONDITIONS	VALUES	UNITS	
Maximum average on-state current	$I_{T(AV)}$	$T_C = 95\text{ }^\circ\text{C}$, 180° conduction half sine wave	25	A	
Maximum RMS on-state current	I_{RMS}		40		
Maximum peak, one-cycle, non-repetitive surge current	I_{TSM}	10 ms sine pulse, rated V_{RRM} applied	400		
		10 ms sine pulse, no voltage reapplied	300		
Maximum I^2t for fusing	I^2t	10 ms sine pulse, rated V_{RRM} applied	310	A^2s	
		10 ms sine pulse, no voltage reapplied	442		
Maximum $I^2\sqrt{t}$ for fusing	$I^2\sqrt{t}$	$t = 0.1$ to 10 ms, no voltage reapplied	4420	$A^2\sqrt{s}$	
Maximum on-state voltage drop	V_{TM}	20 A, $T_J = 25\text{ }^\circ\text{C}$	1.4	V	
On-state slope resistance	r_t	$T_J = 125\text{ }^\circ\text{C}$	12	$m\Omega$	
Threshold voltage	$V_{T(TO)}$		1.0	V	
Maximum reverse and direct leakage current	I_{RM}/I_{DM}	$T_J = 25\text{ }^\circ\text{C}$	$V_R = \text{rated } V_{RRM}/V_{DRM}$	0.5	mA
		$T_J = 125\text{ }^\circ\text{C}$		10	
Maximum holding current	I_H	Anode supply = 6 V, resistive load, initial $I_T = 1$ A, $T_J = 25\text{ }^\circ\text{C}$	150		
Maximum latching current	I_L	Anode supply = 6 V, resistive load, $T_J = 25\text{ }^\circ\text{C}$	200		
Maximum rate of rise of off-state voltage	dV/dt	$T_J = T_J$ maximum, linear to 80 % V_{DRM} , $R_g - k = \text{open}$	500	$V/\mu s$	
Maximum rate of rise of turned-on current	dI/dt		150	$A/\mu s$	

TRIGGERING				
PARAMETER	SYMBOL	TEST CONDITIONS	VALUES	UNITS
Maximum peak gate power	P_{GM}		8.0	W
Maximum average gate power	$P_{G(AV)}$		2.0	
Maximum peak positive gate current	+ I_{GM}		1.5	A
Maximum peak negative gate voltage	- V_{GM}		10	V
Maximum required DC gate current to trigger	I_{GT}	Anode supply = 6 V, resistive load, $T_J = -10\text{ }^\circ\text{C}$	50	mA
		Anode supply = 6 V, resistive load, $T_J = 25\text{ }^\circ\text{C}$	45	
		Anode supply = 6 V, resistive load, $T_J = 125\text{ }^\circ\text{C}$	15	
Maximum required DC gate voltage to trigger	V_{GT}	Anode supply = 6 V, resistive load, $T_J = -10\text{ }^\circ\text{C}$	2.5	V
		Anode supply = 6 V, resistive load, $T_J = 25\text{ }^\circ\text{C}$	2.0	
		Anode supply = 6 V, resistive load, $T_J = 125\text{ }^\circ\text{C}$	1.0	
Maximum DC gate voltage not to trigger	V_{GD}	$T_J = 125\text{ }^\circ\text{C}$, $V_{DRM} = \text{rated value}$	0.25	
Maximum DC gate current not to trigger	I_{GD}		2.0	mA

SWITCHING				
PARAMETER	SYMBOL	TEST CONDITIONS	VALUES	UNITS
Typical turn-on time	t_{gt}	$T_J = 25\text{ }^\circ\text{C}$	0.9	μs
Typical reverse recovery time	t_{rr}	$T_J = 125\text{ }^\circ\text{C}$	4	
Typical turn-off time	t_q		110	

THERMAL AND MECHANICAL SPECIFICATIONS					
PARAMETER		SYMBOL	TEST CONDITIONS	VALUES	UNITS
Maximum junction and storage temperature range		T_J, T_{Stg}		-40 to 125	°C
Maximum thermal resistance, junction to case		R_{thJC}	DC operation	0.8	°C/W
Maximum thermal resistance, junction to ambient		R_{thJA}		40	
Maximum thermal resistance, case to heatsink		R_{thCS}		0.2	
Approximate weight				6	g
				0.21	oz.
Mounting torque	minimum			6 (5)	kgf · cm (lbf · in)
	maximum			12 (10)	
Marking device			Case style TO-247AD 3L	30TPS16H	

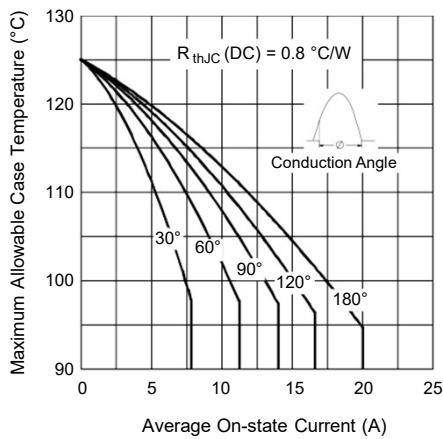

Fig. 1 - Current Rating Characteristics

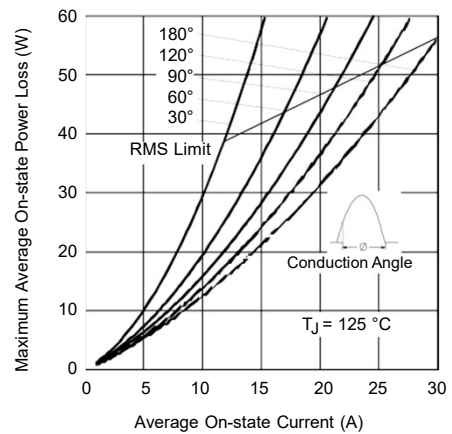

Fig. 3 - On-State Power Loss Characteristics

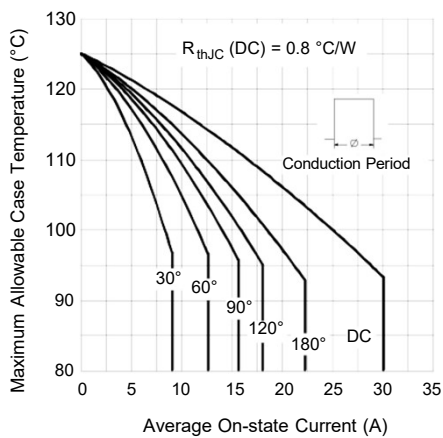

Fig. 2 - Current Rating Characteristics

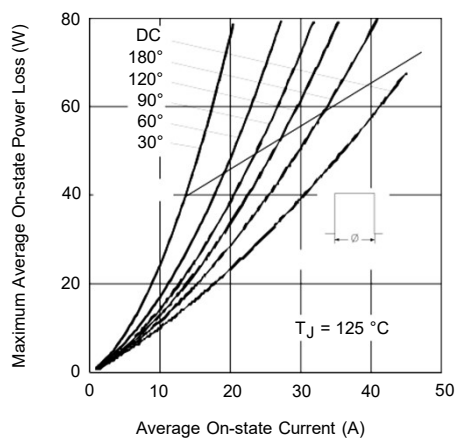

Fig. 4 - On-State Power Loss Characteristics

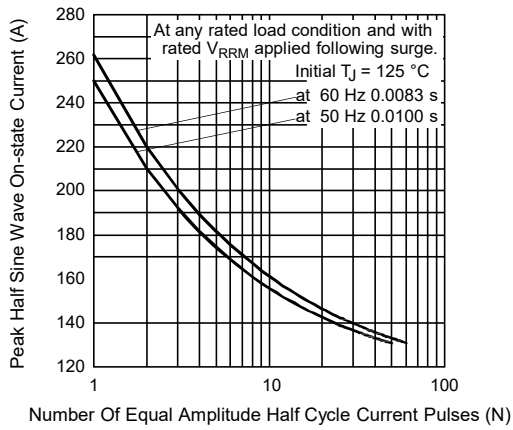

Fig. 5 - Maximum Non-Repetitive Surge Current

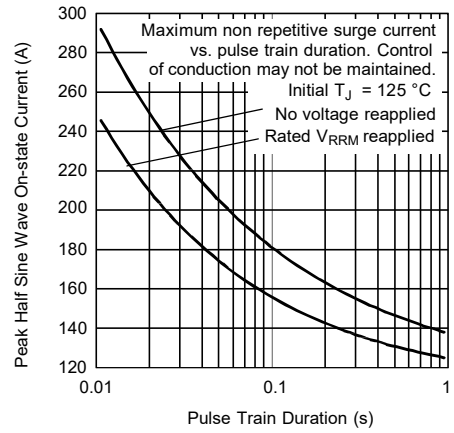

Fig. 6 - Maximum Non-Repetitive Surge Current

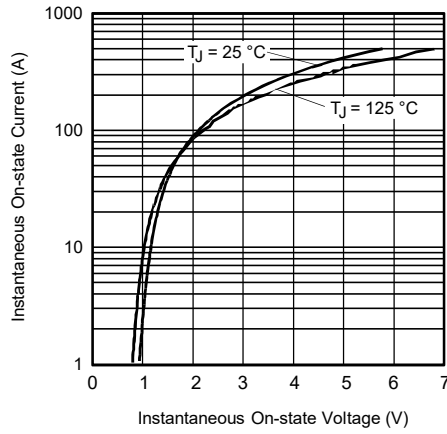

Fig. 7 - On-State Voltage Drop Characteristics

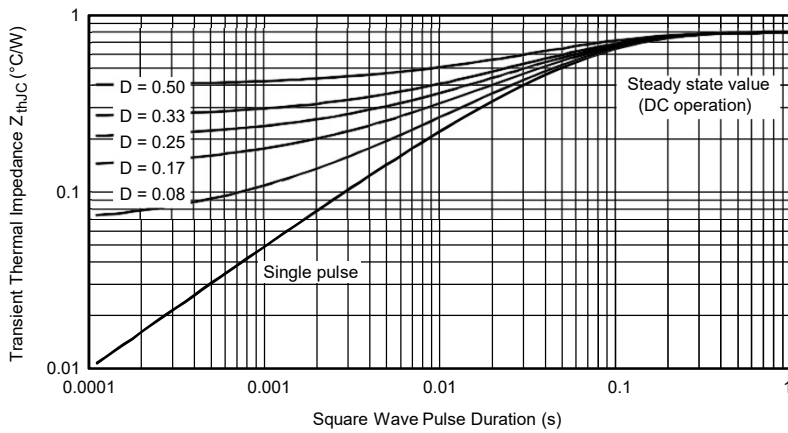
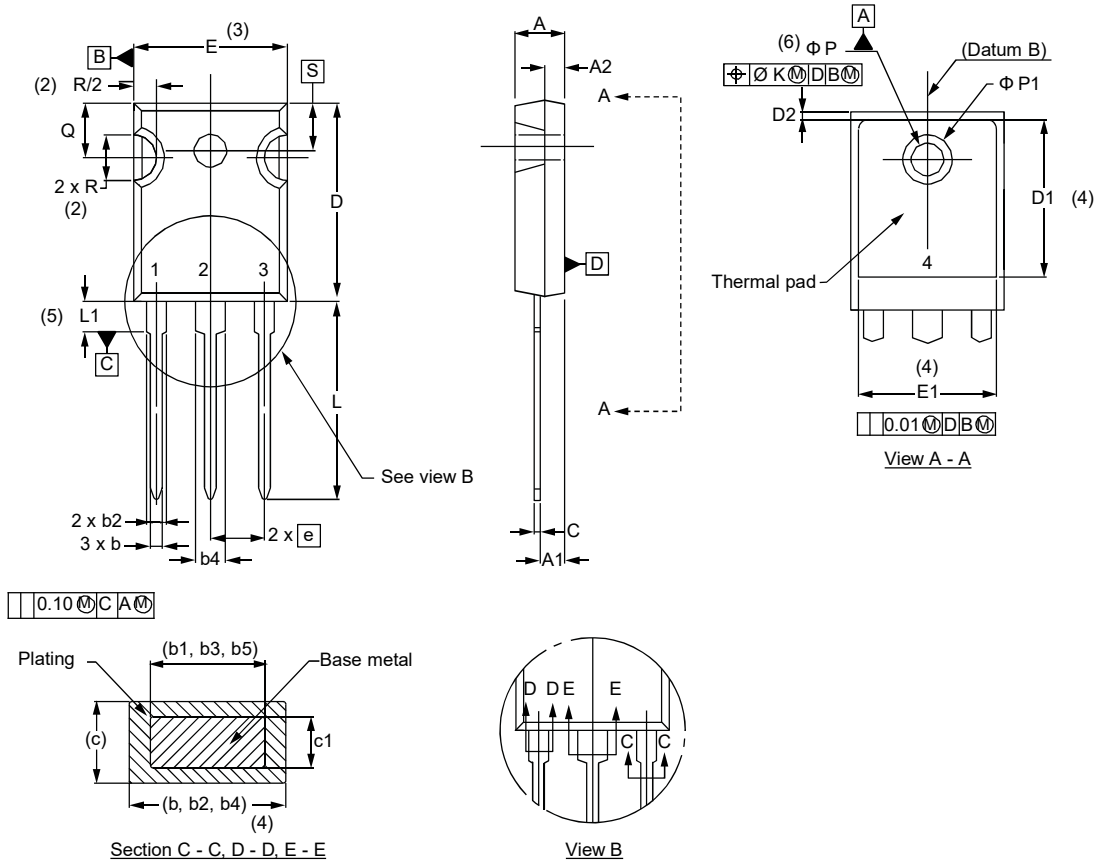

Fig. 8 - Thermal Impedance Z_{thJC} Characteristics

TO-247AD 3L

DIMENSIONS in millimeters and inches



SYMBOL	MILLIMETERS		INCHES		NOTES
	MIN.	MAX.	MIN.	MAX.	
A	4.65	5.31	0.183	0.209	
A1	2.21	2.59	0.087	0.102	
A2	1.50	2.49	0.059	0.098	
b	0.99	1.40	0.039	0.055	
b1	0.99	1.35	0.039	0.053	
b2	1.65	2.39	0.065	0.094	
b3	1.65	2.34	0.065	0.092	
b4	2.59	3.43	0.102	0.135	
b5	2.59	3.38	0.102	0.133	
c	0.38	0.89	0.015	0.035	
c1	0.38	0.84	0.015	0.033	
D	19.71	20.70	0.776	0.815	3
D1	13.08	-	0.515	-	4

SYMBOL	MILLIMETERS		INCHES		NOTES
	MIN.	MAX.	MIN.	MAX.	
D2	0.51	1.30	0.020	0.051	
E	15.29	15.87	0.602	0.625	3
E1	13.46	-	0.53	-	
e	5.46 BSC		0.215 BSC		
Ø K	2.54		0.010		
L	19.81	20.32	0.780	0.800	
L1	3.71	4.29	0.146	0.169	
Ø P	3.56	3.66	0.14	0.144	
Ø P1	-	6.98	-	0.275	
Q	5.31	5.69	0.209	0.224	
R	4.52	5.49	0.178	0.216	
S	5.51 BSC		0.217 BSC		